

Entrematic CS12E

IP2162EN • 2018-09-06

Control panel installation manual for Ditec NEOS automations

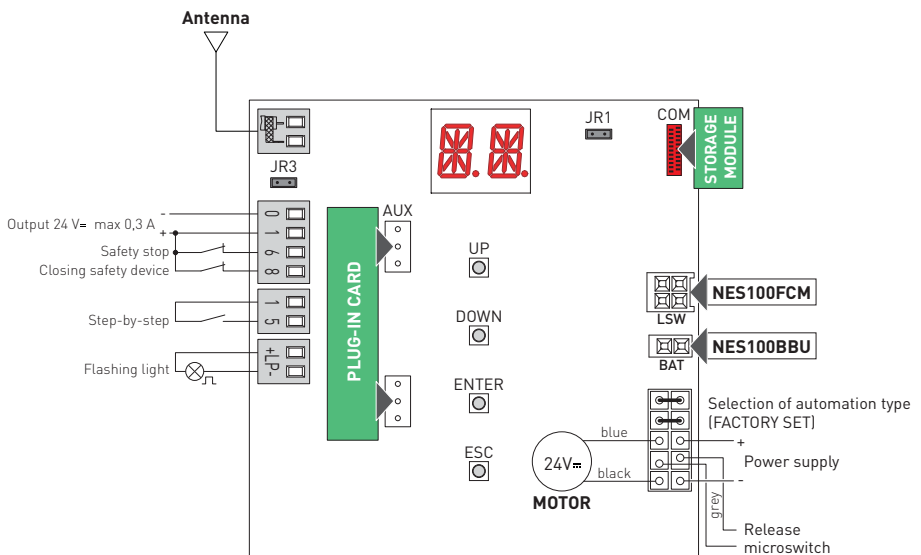

Index

Subject		Page
1.	General safety precautions	3
2.	EC Declaration of Conformity	4
3.	Technical specifications	4
4.	Commands	5
4.1	Inserting plug-in card (AUX)	6
4.2	Self-controlled safety edge	6
5.	Outputs and accessories	8
6.	Selections	9
7.	Settings	9
7.1	Switching on and off	9
7.2	Key combinations	10
7.3	Main menu	11
7.4	Second level menu - AT (Automatic Configurations)	12
7.5	Second level menu - BC (Basic Configurations)	14
7.6	Second level menu - BA (Basic Adjustment)	16
7.7	Second level menu - RO (Radio Operations)	20
7.8	Second level menu - SF (Special Functions)	23
7.9	Second level menu - CC (Cycles Counter)	25
7.10	Second level menu - AP (Advanced Parameters)	27
8.	Display visualisation mode	31
8.1	Display of automation status	31
8.2	Display of safety devices and commands	33
8.3	Display of alarms and faults	35
9.	Start-up	38
10.	Troubleshooting	39
11.	Examples of application	41
	Quick Reference	44

Key



This symbol indicates instructions or notes regarding safety, to which special attention must be paid.



This symbol indicates useful information for the correct functioning of the product.



Factory settings

1. General safety precautions



Failure to observe the information given in this manual may lead to personal injury or damage to the equipment.

Keep these instructions for future reference

This installation manual is intended for qualified personnel only.

Installation, electrical connections and adjustments must be performed in accordance with Good Working Methods and in compliance with the present standards.

This product must only be used for the specific purpose for which it was designed.

Any other use is to be considered improper and therefore dangerous. The manufacturer cannot be held responsible for any damage caused by improper, incorrect or unreasonable use.

Read the instructions carefully before installing the product. Incorrect installation could be dangerous.



The packaging materials (plastic, polystyrene, etc.) should not be discarded in the environment or left within reach of children, as they are a potential source of danger.

Before installing the product, make sure it is in perfect condition.

Do not install the product in explosive areas and atmospheres: the presence of inflammable gas or fumes represents a serious safety hazard.

The safety devices (photocells, safety edges, emergency stops, etc.) must be installed taking into account the applicable laws and directives, Good Working Methods, installation premises, system operating logic and the forces developed by the automation.

Before connecting the power supply, make sure the plate data correspond to those of the mains power supply. An omnipolar disconnection switch with a contact opening distance of at least 3 mm must be fitted on the mains supply.

Check that there is an adequate residual current circuit breaker and a suitable overcurrent cut-out upstream of the electrical installation in accordance with Good Working Methods and with the laws in force.

When requested, connect the automation to an effective earthing system that complies with current safety standards.



During installation, maintenance and repair operations, cut off the power supply before opening the cover to access the electrical parts.



The electronic parts must be handled using earthed antistatic conductive arms.

The manufacturer of the motorisation device declines all responsibility if component parts not compatible with safe and correct operation are fitted.

Only use original spare parts when repairing or replacing products.

1.1 Safety functions

The CS12E control panel has the following safety functions:

- obstacle recognition with force limiting;

The maximum response time of the safety functions is 0.5 s. The reaction time to a faulty safety function is 0.5 s.

The safety functions comply with the standards and performance level indicated below:

EN ISO 13849-1:2008 Category 2 PL=c

EN ISO 13849-2:2012

The safety function cannot be bypassed either temporarily or automatically. Fault exclusion has not been applied.

2. EC Declaration of Conformity

The manufacturer Entrematic Group AB, with headquarters in Lodjursgatan 10, SE-261 44 Landskrona, Sweden, declares that the Entrematic CS12E type control panel complies with the conditions of the following EC directives:

2014/30/EU (EMCD)

2014/35/EU (LVD)









2014/53/EU (RED)

Landskrona, 07-09-2018

Matteo Fino
President & CEO





3. Technical specifications

Description	NES300EH	NES400EH	NES600EH	NES600EHSF
Power supply	230 V~ 50/60 Hz	230 V~ 50/60 Hz	230 V~ 50/60 Hz	230 V~ 50/60 Hz
Motor output	24 V~ 12 A max	24 V~ 14 A max	24 V~ 16 A max	24 V~ 16 A max
Accessories power supply	24 V~ 0,3 A max	24 V~ 0,3 A max	24 V~ 0,3 A max	24 V~ 0,3 A max
Operating temperature	 -20 °C  +55 °C	 -20 °C  +55 °C	 -20 °C  +55 °C	 -20 °C  +55 °C
Storable radio codes	100 200 [BIXMR2]	100 200 [BIXMR2]	100 200 [BIXMR2]	100 200 [BIXMR2]
Radio frequency	433,92 MHz	433,92 MHz	433,92 MHz	433,92 MHz

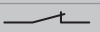
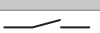

N.B.: The given operating and performance features can only be guaranteed with the use of DITEC Entrematic accessories and safety devices.

4. Commands

Command	Function	Description
1  5 NO	STEP-BY-STEP WITH AUTOMATIC CLOSING	When selecting BC → CS → I-5 , closing the contact starts a sequential opening or closing operation: opening-stop-closing-opening. WARNING: if automatic closing is enabled, the duration of the stop can be selected by selecting BC → SS .
	STEP-BY-STEP WITHOUT AUTOMATIC CLOSING	When selecting BC → CS → I-5 , closing the contact starts a sequential opening or closing operation: opening-stop-closing-opening.
	OPENING WITH AUTOMATIC CLOSING	When selecting BC → CS → I-3 , closing the contact activates an opening operation.
	OPENING WITHOUT AUTOMATIC CLOSING	When selecting BC → CS → I-3 , closing the contact activates an opening operation. N.B.: Once the automation stops, command 1-5 performs the opposite operation to the one performed before the stop.
1  6 NC	CLOSING SAFETY DEVICE	When selecting BC → 64 → I-6 , opening of the safety contact stops and prevents any movement. N.B.: to set different safety contact functions, see the AP → SM parameter settings.
1  6 NO	CLOSING	When selecting BC → 64 → I-4 , closing the contact activates a closing operation.
1  8 NC	CLOSING SAFETY DEVICE	Opening the safety contact triggers a reversal of the movement (reopening) during the closing operation. When selecting BC → 50 → ON , with the automation idle, opening of the contact prevents any operation. When selecting BC → 50 → OF , with the automation idle, opening of the contact only prevents closing.





4.1 Inserting plug-in card (AUX)

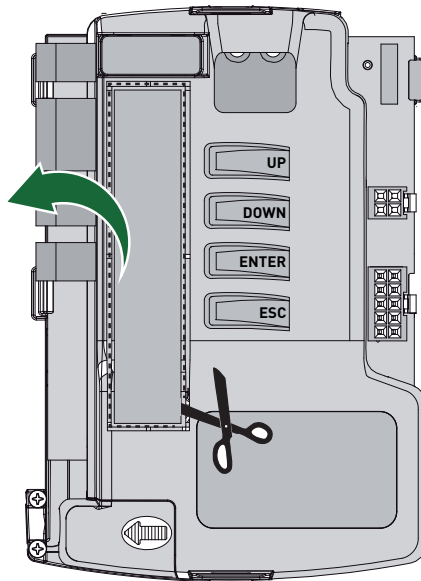





To access the plug-in card (AUX), cut the control panel cover as shown in the figure.



4.2 SOFA1-SOFA2 or GOPAVRS self-controlled safety edge

Command	Function	Description
	SAFETY TEST	Place the SOFA1-SOFA2 or GOPAVRS device into the special housing for AUX plug-in cards. If the test fails, an alarm message appears on the display.
	NC	SAFETY STOP
	NC	CLOSING SAFETY DEVICE

5. Outputs and accessories

Output	Value Accessories	Description
	24 V $\overline{\text{=}}$ 0.3 A	Accessories power supply. External accessories power supply output. N.B.: the maximum absorption of 0.3 A corresponds to the sum of all terminals 1.
	GOL148REA (433, 92 MHz)	Antenna connection (433, 92 MHz). If the inside radio receiver is used, connect the supplied antenna wire (173 mm), or alternatively the GOL148REA antenna, using a coaxial cable, type RG58.
	LAMPH 24 V $\overline{\text{=}}$ 25 W	Flashing light. The pre-flashing settings can be selected from the third level menu AP \rightarrow WO and/or AP \rightarrow WC .
AUX		The control panel has a housing for plug-in cards. The action of the card can be selected by selecting BC \rightarrow AM . WARNING: the plug-in cards must be inserted and removed with the power supply disconnected.
	BIXMR2	This allows the functioning configurations to be saved using the function SF \rightarrow SV . The saved configurations can be recalled using the function SF \rightarrow RC . The storage module allows the remote controls to be stored. If the control panel is replaced, the storage module being used can be inserted in the new control panel. WARNING: the storage module must be inserted and removed with the power supply disconnected.
	NES100FCM	Magnetic limit switch kit (optional only for Ditec NES300 - NES400).
	NES100BBU 2x12 V 2Ah	BAT - Batteries functioning. The batteries are kept charged when the power supply is on. If the power supply is off, the panel is powered by the batteries until the power is re-establish or until the battery voltage drops below the safety threshold. The panel turns off in the last case. WARNING: the batteries must always be connected to the control panel for charging. Periodically check the efficiency of the batteries. N.B.: the operating temperature of the rechargeable batteries is approximately +5°C/+40°C.
		Mains power supply, motor, release microswitch and automation wiring connection.

6. Selections

Jumper	Description	OFF	ON
JR1	Display mode selection.	Display mode. Only the values and parameters present can be displayed.	Maintenance mode. Only the values and parameters present can be displayed and modified. Going into maintenance mode is indicated by the permanent switching on of the right-hand point on the display.
JR3	Built-in radio receiver.	Disabled.	Enabled.

7. Settings



N.B.: pressure on the keys can be quick (less than 2 s) or prolonged (longer than 2 s). Unless specified otherwise, quick pressure is intended.

7.1 Switching the display on and off

The procedure to switch on the display is as follows:

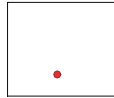

- press the ENTER key



- the display functioning check starts



- the first level menu is displayed

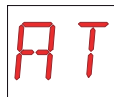

The procedure to switch off the display is as follows:

- press the ESC key



N.B.: the display switches off automatically after 60 s of inactivity.

7.2 Key combinations

- Simultaneous pressing of the keys \uparrow and ENTER performs an opening command.



- Simultaneous pressing of the keys \downarrow and ENTER performs a closing command.



- Simultaneous pressing of the keys \uparrow and \downarrow performs a POWER RESET command. (interruption of the power supply and restart of the automation).

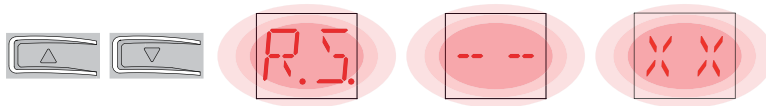

- Keeping press the UP \uparrow or DOWN \downarrow key, fast menu scrolling begin. To stop menu scrolling.
- In some menus, the parameter unit of measurement can be displayed by pressing the ENTER key once the value has been displayed (in the example, 50 cm).

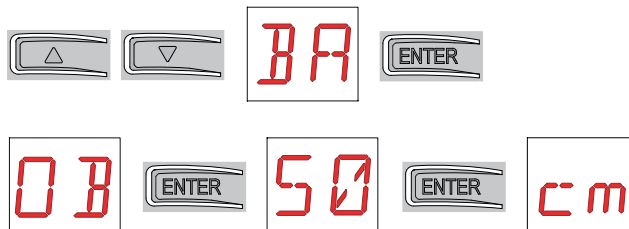

7.3 Main menu

- using keys ↑ and ↓ select the desired function



- press the ENTER key to confirm



After confirming the selection, you access the second level menu.

Display	Description
AT	AT - Automatic Configurations. The menu allows you to manage the automatic configurations of the control panel.
BC	BC - Basic Configurations. The menu allows you to display and modify the main settings of the control panel.
BA	BA - Basic Adjustments. The menu allows you to display and modify the main adjustments of the control panel. N.B.: some settings require at least three operations before they are set correctly.
RO	RO - Radio Operations. The menu allows you to manage the radio operations of the control panel.
SF	SF - Special Functions. The menu allows you to set the password and manage the special functions in the control panel.
CC	CC - Cycles Counter. The menu allows you to display the number of operations carried out by the automation and manage the maintenance interventions.
AP	AP - Advanced Parameters. The menu allows you to display and modify the advanced settings and adjustments of the control panel. N.B.: some settings require at least three operations before they are set correctly.



WARNING: depending on the type of automation and control panel, some menus may not be available.

7.4 Second level menu AT (Automatic Configurations)



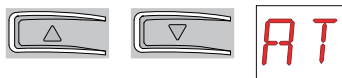

- using keys \uparrow and \downarrow select the desired function

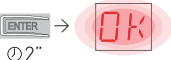

- press the ENTER key to confirm



Display	Description
	RT - Opening to right.
	LF - Opening to left.
	H0 - Predefined setting, residential use 0. This selection loads predefined values for certain standard parameters: AC - enabling of automatic closing : disabled C5 - step-by-step/opening command operation : step-by-step RM - remote control operation : step-by-step AM - AUX plug-in card operation : step-by-step SS - Selection of automation status at start-up : open
	H1 - Predefined setting, residential use 1. This selection loads predefined values for certain standard parameters: AC - enabling of automatic closing : enabled TC - setting of automatic closing time : 1 minute C5 - step-by-step/opening command operation : step-by-step RM - remote control operation : step-by-step AM - AUX plug-in card operation : step-by-step SS - Selection of automation status at start-up : closed
	C0 - Predefined setting, condominium use 0. This selection loads predefined values for certain standard parameters: AC - enabling of automatic closing : enabled TC - setting of automatic closing time : 1 minute C5 - step-by-step/opening command operation : opening RM - remote control operation : opening AM - AUX plug-in card operation : opening SS - Selection of automation status at start-up : closed
	RD - Resetting of general settings (SETTINGS RESET).  $\varnothing 2''$

Display	Description
 	<p data-bbox="296 119 716 151">AA - Activating advanced parameters menu.</p>  <p data-bbox="431 231 487 263">⌚ 2"</p> <p data-bbox="296 343 800 422">After activation you can scroll through the third level menus. The third level menus are activated for 30 min.</p>
	



Depending on the type of automation and control panel, some menus may not be available.

7.5 Second level menu - BC (Basic Configurations)

- using keys ↑ and ↓ select the desired function

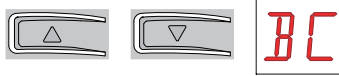

- press the ENTER key to confirm



BC - Basic configurations	Display	Description		
	AC	AC - Enabling of automatic closing. ON - Enabled OF - Disabled	ON	OF
	SS	SS - Selection of automation status at start. OP - Open CL - Closed Indicates how the control panel considers the automation at the time of switch-on, or after a POWER RESET command.	OP	CL
	SO	SO - Enabling of reversal safety contact functioning. ON - Enabled OF - Disabled When enabled (ON) with the automation idle, if the contact 1-8 is open, all operations are prevented. When disabled (OF) with the automation idle, if the contact 1-8 is open, opening operations are permitted.	ON	OF
	NI	NI - Enabling of NIO electronic anti-freeze system. ON - Enabled OF - Disabled When enabled (ON) it maintains motor efficiency even at low ambient temperatures, increases the starting time ST to the maximum value and reduces the acceleration time TA to the minimum value. N.B.: for correct operation, the control panel must be exposed to the same ambient temperature as the motors.	ON	OF



WARNING: depending on the type of automation and control panel, some menus may not be available.

7.5.1 Additional BC level parameters that can be configured (available with **AT** → **AA** enabled)

Display	Description		
HR	HR - Enabling of operator present function ON - Enabled OF - Disabled N.B.: Set HR → ON only if 64 → 1-4 and C5 → 1-3 .	ON	OF <u> </u>
64	64 - Functioning of safety stop/closing command. 1-4 - Closing 1-6 - Safety stop	1-4	1-6 <u> </u>
C5	C5 - Step-by-step/opening command operation. 1-5 - Step-by-step 1-3 - Opening	1-5 <u> </u>	1-3
RM	RM - Radio receiver operation. 1-5 - Step-by-step 1-3 - Opening	1-5 <u> </u>	1-3
AM	AM - AUX plug-in card operation. 1-5 - Step-by-step 1-3 - Opening	1-5 <u> </u>	1-3
PP	PP - Setting step-by-step sequence from command 1-5. ON - Opening-Stop-Closing-Stop-Opening OF - Opening-Stop-Closing-Opening	ON	OF <u> </u>
S5	S5 - Duration of STOP in step-by-step sequence from command 1-5. ON - Permanent OF - Temporary	ON	OF <u> </u>
OD	OD - Selecting opening direction. LF - Opening to left. RT - Opening to right. The opening direction is intended by viewing the automation from the side being examined. N.B.: Modification of status from RT to LF and vice versa performs an automatic RESET of the card.	LF	RT <u> </u>

7.6 Second level menu - BA (Basic Adjustment)

- using keys ↑ and ↓ select the desired function







- press the ENTER key to confirm



Display	Description	
BA - Basic adjustment	MT - Display of type of automation. N3 - Motor with 300 kg capacity N4 - Motor with 400 kg capacity N6 - Motor with 600 kg capacity SF - Motor Super Fast with 600 kg capacity N.B.: this parameter is DISPLAY only.	N3 N4 N6 SF
	TC - Setting of automatic closing time. [s] It is set with different intervals of sensitivity. <ul style="list-style-type: none"> from 0" to 59" with intervals of 1 second; from 1' to 2' with intervals of 10 seconds. 	00'59" 1' 21" 1'00"
	RP - Adjustment of partial opening measurement. [%] Adjusts the percentage of operation in relation to the total opening of the automation. 10 - Minimum 99 - Maximum	10'99" 30
	TP - Setting of automatic closing time after partial opening. [s] It is set with different intervals of sensitivity. <ul style="list-style-type: none"> from 0" to 59" with intervals of 1 second; from 1' to 2' with intervals of 10 seconds. 	00'59" 1' 21" 00'30"
	VA - Setting of opening speed. [cm/s] N.B.: 24 - Maximum with MT → N6 25 - Maximum with MT → N3 or N4 40 - Maximum with MT → SF	10'25" 15 Neos Super Fast 10'40" 25

BA - Basic adjustment

Display	Description
	VC - Setting of closing speed. [cm/s] N.B.: 24 - Maximum with MT → N6 25 - Maximum with MT → N3 or N4 40 - Maximum with MT → SF
	 Neos Super Fast 
	R2 - Adjustment of thrust on obstacles and current during opening [%] The control panel is equipped with a safety device that stops movement if an obstacle is detected during an opening operation with disengagement of 10 cm. 00 - Minimum thrust 99 - Maximum thrust
	R1 - Adjustment of thrust on obstacles and current during closing [%] The control panel is fitted with a safety device which stops or reverses movement when an obstacle is detected during a closing operation. 00 - Minimum thrust 99 - Maximum thrust









WARNING: depending on the type of automation and control panel, some menus may not be available.



N.B.: make adjustments gradually and only after performing at least three complete operations to allow the control panel to be set correctly and detect any friction during operations.

7.6.1 Additional BA level parameters that can be configured (available with **AT** → **AA** enabled)

Display	Description	
DT	DT - Adjustment of obstacle recognition time. [s/100] 10 - Minimum 60 - Maximum N.B.: the parameter is adjusted in hundredths of a second.	1060 40
MP	MP - Start at maximum power ON - During start-up it increases the thrust on obstacles to maximum. OFF - During start-up the thrust on obstacles is that adjusted by R 1 - R2	<u>ON</u> OFF
ST	ST - Adjustment of start time. [s] 0.5 - Minimum 3.0 - Maximum Neos Super fast 1,0 - Minimum 4,0 - Maximum	0.5 ▶ 3.0 2.0
		Neos Super Fast 1.0 ▶ 4.0 3.0
TA	TA - Adjustment of acceleration time. [s] (start speed is 75% of V A - V C) 0.5 - Minimum 2.0 - Maximum Neos Super fast 1,0 - Minimum 4,0 - Maximum	0.5 ▶ 2.0 1.5
		Neos Super Fast 1.0 ▶ 4.0 3.0
TD	TD - Adjustment of deceleration time. [%] 10 - Minimum 99 - Maximum	10 ▶ 99 75
OB	OB - Adjustment of deceleration distance during opening. [cm] Indicates the distance from the end of the opening stroke where the deceleration ramp begins. 05 - Minimum 99 - Maximum N.B.: reduce the deceleration space if there is a series of quick vibrations (chattering) in heavy gates installed with a slight incline.	05 ▶ 99 40
		Neos Super Fast 20 ▶ 99 99

Display	Description	
CB	OB - Adjustment of deceleration distance during closing. [cm] Indicates the distance from the end of the closing stroke where the deceleration ramp begins. 05 - Minimum , (20 - Neos Super Fast) 99 - Maximum N.B.: reduce the deceleration space if there is a series of quick vibrations (chattering) in heavy gates installed with a slight incline.	
		Neos Super Fast 
PO	P0 - Adjustment of approach speed during opening. [cm/s] Indicates the speed from the end of the deceleration ramp to the end of the stroke. 02 - Minimum 10 - Maximum N.B.: gradually increase the approach speed if there is a series of quick vibrations (chattering) in heavy gates installed with a slight incline.	
PC	PC - Adjustment of approach speed during closing. [cm/s] Indicates the speed from the end of the deceleration ramp to the end of the stroke. 02 - Minimum 10 - Maximum N.B.: gradually increase the approach speed if there is a series of quick vibrations (chattering) in heavy gates installed with a slight incline.	
00	00 - Obstacle detection limit during opening [cm] Indicates the distance from the end of the opening stroke after which each obstacle is considered a stop. 05 - Minimum 99 - Maximum N.B.: This parameter is only active if AP → FA → NO	
0C	0C - Obstacle detection limit during closing [cm] Indicates the distance from the end of the closing stroke after which each obstacle is considered a stop. 05 - Minimum 99 - Maximum N.B.: This parameter is only active if AP → FC → NO	



N.B.: make adjustments gradually and only after performing at least three complete operations to allow the control panel to be set correctly and detect any friction during operations.

7.7 Second level menu - RO (Radio Operations)

- using keys ↑ and ↓ select the desired function

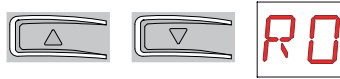

- press the ENTER key to confirm



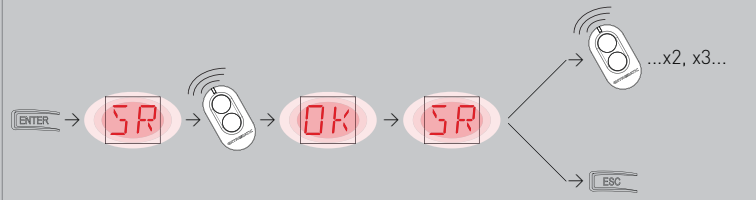
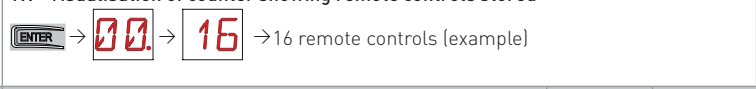
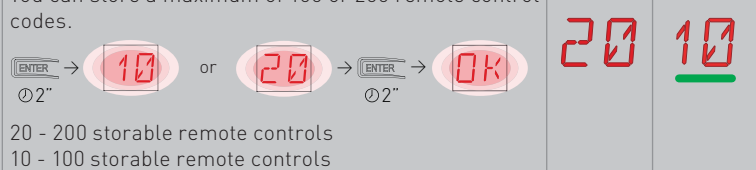

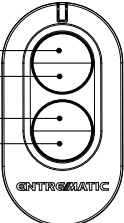
RO - Radio operations	Display	Description
	SR	<p>SR - Remote control storage. You can directly access the Remote control storage menu even with the display turned off, but only with the Display visualisation mode option set to 00 or 03:</p> <ul style="list-style-type: none"> - for transmitting a remote control not present in the memory; - for transmitting an unstored channel of a remote control already present in the memory. 
	TX	<p>TX - Visualisation of counter showing remote controls stored</p> 
	MU	<p>MU - Indication of maximum number of remote controls that can be stored in the integrated memory. You can store a maximum of 100 or 200 remote control codes.</p>  <p>20 - 200 storable remote controls 10 - 100 storable remote controls</p>

Display	Description	
<p>RK</p>	<p>RK - Menu navigation using remote control keyboard ON - Enabled OF - Disabled</p> <p>With the display turned off, quickly type in the sequence of keys 3 3 2 4 1 from the stored remote control you want to use.</p> <p>Make sure all the CH keys are stored.</p> <p>WARNING: during navigation with a remote control keyboard ALL the stored remote controls are inactive.</p> <div style="text-align: center;">  </div> <p>To make viewing and adjustment easier (avoiding the need to continuously press the remote control), press the UP ↑ or DOWN ↓ key once to begin slowly scrolling through the parameters.</p> <p>This scrolling movement is faster if the UP ↑ or DOWN ↓ key is pressed twice.</p> <p>To stop the scrolling, press ENTER.</p> <p>To confirm your choice of parameter, press ENTER again.</p> <p>To test any new setting, switch off the display and issue an opening command using key 3.</p> <p>Navigation using a remote control keyboard is automatically disabled after 4 minutes of inactivity or by setting RK → OF.</p>	<p>ON OF</p>



WARNING: depending on the type of automation and control panel, some menus may not be available.

7.7.1 Additional RO level parameters that can be configured (available with **AT** → **AA** enabled)

Display	Description		
RO C1 C2 C3 C4	C1, C2, C3, C4 - Selection of CH1, CH2, CH3, CH4 function of stored remote control. NO - No setting selected 1-3 - Opening command 1-4 - Closing command 1-5 - Step-by-step command P3 - Partial opening command 1-9 - STOP command If only one (any) CH key of the remote control is stored, command 1-3 (step-by-step/opening) is carried out. If 2-4 CH keys of a single remote control are stored, the functions matched with the CH keys are as follows: <ul style="list-style-type: none"> • CH1 = command 1-3 step-by-step/opening; • CH2 = partial opening command; • CH3 = no setting selected; • CH4 = STOP command. WARNING: options 1-3 (opening) and 1-5 (step-by-step) are available as an alternative and depend on the selection BC → RM .	NO	1-3
		1-5	1-4
		P3	1-9
ER	ER - Cancelling a single remote control. 		
EA	EA - Cancelling an entire memory. 		
EC	EC - Cancelling a single code. (FOR FUTURE USE)		
RE	RE - Setting memory opening from remote control. OF - Disabled ON - Enabled When enabled (ON), the remote programming is activated. To store new remote controls without using the control panel, press the PRG key of an already stored GOL4 remote control for 5 seconds until the LED comes on (within the range of the receiver) and press any one of the CH keys on the new remote control. N.B.: make sure you do not accidentally memorise unwanted remote controls.	ON	OF
	EP	EP - Setting the coded area messages If the possibility to receive coded messages is enabled, the control panel will be compatible with remote controls of the "EN-CRYPTED" type.	ON

7.8 Second level menu - SF (Special Functions)

- using keys \uparrow and \downarrow select the desired function

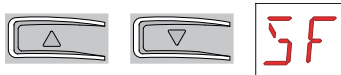

- press the ENTER key to confirm





Display	Description
CU	<p>CU - Displaying the control panel firmware version.</p> <p> → Release 1.1 (example)</p>
SV	<p>SV - Saving user configuration on control panel storage module.</p> <p> → $\emptyset 2''$</p> <p>By selecting RO → MU → 10 you can save up to 2 personalised configurations in memory positions U 1 and U 2 only with the storage module present on the control panel.</p> <p>WARNING: if more than 100 remote control codes are stored on the control panel storage module, you cannot save any user configuration.</p>
RC	<p>RC - Loading configuration.</p> <p> → $\emptyset 2''$</p> <p>You can upload the user configurations previously saved U 1 and U 2 on the control panel storage module, or upload the predefined settings available in memory positions 0 1.02.03 and 04.</p> <p>01 - parameter setting for passive edge on closure edge and stopping limit switch.</p> <p>02 - parameter setting for passive edges on both edges and stopping limit switch.</p> <p>03 - FUTURE USE</p> <p>04 - FUTURE USE</p>
RL	<p>RL - Loading the last configuration set.</p> <p> → $\emptyset 2''$</p> <p>The control panel automatically saves the last configuration set, and keeps it memorised in the storage module. In the event of a fault or the replacement of the control panel, the last configuration of the automation can be restored by inserting the storage module and loading the last configuration set.</p>

SF - Special functions



WARNING: depending on the type of automation and control panel, some menus may not be available.

7.8.1 Additional SF level parameters that can be configured (available with **AT** → **AA** enabled)

Display	Description
<p style="font-size: 2em; color: red; font-weight: bold;">SP</p>	<p>SP - Setting the password.</p>  <p>N.B.: this can only be selected when the password is not set. Setting the password prevents unauthorised personnel from accessing selections and adjustments. You can delete the set password by selecting the sequence JR1=ON, JR1=OFF, JR1=ON.</p>
<p style="font-size: 2em; color: red; font-weight: bold;">IP</p>	<p>IP - Inserting the password.</p>  <p>N.B.: this can only be selected when the password is set. When the password is not inserted, you can access the display mode regardless of the selection made with JR1. When the password is inserted, you can access in maintenance mode.</p>
<p style="font-size: 2em; color: red; font-weight: bold;">EU</p>	<p>EU - Cancellation of user configurations and last configuration set in the storage module.</p> 

7.9 Second level menu - CC (Cycles Counter)

- using keys ↑ and ↓ select the desired function

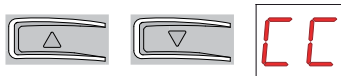

- press the ENTER key to confirm



CC - Cycles counter	Display	Description
		CV - Display of total operations counter. → → → → 182 operations (example)
		CP - Display of partial operations counter. → → → → 716 operations (example)
		CH - Display of power supply hour counter. → → → → 256 hours of power (example)



WARNING: depending on the type of automation and control panel, some menus may not be available.

7.10 Second level menu - AP (Advanced Parameters)

- using keys ↑ and ↓ select the desired function

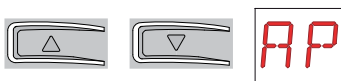

- press the ENTER key to confirm



Display	Description		
FA	FA - Selection of opening limit switch mode. NO - None SX - Stop limit switch (after activation the door wing stops its movement) PX - Proximity limit switch (after activation the door wing continues as far as the end stop and any obstacle is considered a stop) ----- (with standard limit switches)	NO -----	SX -----
		PX	
FC	FC - Selection of closing limit switch mode. NO - None SX - Stop limit switch (after activation the door wing stops its movement) PX - Proximity limit switch (after activation the door wing continues as far as the end stop and any obstacle is considered a stop) ----- (with standard limit switches)	NO -----	SX -----
		PX	
D6	D6 - Selection of device connected to terminals 1-6. NO - None SE - Safety edge (if contact 1-6 opens, after stopping, there is a disengagement of 10 cm) S41 - Safety edge with safety test (if contact 1-6 opens, after stopping, there is a disengagement of 10 cm) PH - Photocells P41 - Photocells with safety test	NO	SE
		S41	PH
		P41	-----
D8	D8 - Selection of device connected to terminals 1-8. NO - None SE - Safety edge S41 - Safety edge with safety test PH - Photocells P41 - Photocells with safety test	NO	SE
		S41	PH
		P41	-----

Display	Description		
	DS - Setting of display visualisation mode.		
	00 - No display		
	01 - Commands and safety devices with radio test (see paragraph 8.2). Display of count down to automatic closing.		
	02 - Automation status (see paragraph 8.1) 03 - Commands and safety devices (see paragraph 8.2)		



WARNING: depending on the type of automation and control panel, some menus may not be available.



N.B.: make adjustments gradually and only after performing at least three complete operations to allow the control panel to be set correctly and detect any friction during operations.

7.10.1 Additional AP level parameters that can be configured (available with **AT** → **AA** enabled)

Display	Description		
DO	DO - Setting of disengagement on stop during opening. [mm] 00 - Minimum 10 - Maximum N.B.: Not active if FA → SX	00 ▶ 10	02
DC	DC - Setting of disengagement on stop during closing. [mm] 00 - Minimum 10 - Maximum N.B.: Not active if FC → SX	00 ▶ 10	02
OT	OT - Selection of type of obstacle. 00 - Overcurrent or door stopped 01 - Overcurrent 02 - Door stopped	00 01 02	<u>01</u>
CR	CR - Correction to calculated speed. [mm/s] DO NOT USE	-9 ▶ +9	
R9	R9 - Enabling automatic closing after command 1-9 via radio (STOP). ON - Enabled OF - Disabled When enabled (ON), after a command 1-9 via radio, the automation carries out automatic closing (if enabled), after the set time.	ON	<u>OF</u>
SM	SM - Selection of operating mode of device connected to terminals 1-6. 00 - During the operation, the opening of the safety contact stops movement (with disengagement if DB → SE/S4I). 01 - During the operation, the opening of the safety contact stops movement (with disengagement if DB → SE/S4I). When the contact closes again, the interrupted operation continues. 02 - During the operation, the opening of the safety contact stops movement (with disengagement if DB → SE/S4I). When the contact closes again, an opening operation is performed. 03 - During the opening operation, the opening of the safety contact stops movement (with disengagement if DB → SE / S4I). When the contact closes again, the interrupted opening operation is resumed. During the closing operation, the safety device is ignored. 04 - During the closing operation, the opening of the safety contact reverses the movement. During the opening operation, the safety device is ignored. 05 - During the closing operation, the opening of the safety contact stops and reverses the movement. During the opening operation, opening of the safety contact stops movement (with disengagement if DB → SE / S4I).	<u>00</u> 01 02 03 04 05	

AP

Display	Description	
TN	TN - Setting of intervention temperature for NIO anti-freeze system. [°C] Adjustment of the working temperature of the control panel. The value does not refer to ambient temperature.	-- 920 5
TB	TB - Display of working temperature of control panel. DO NOT USE	
WO	WO - Setting of pre-flashing time on opening. [s] Adjustment of the lead time for the switch-on of the flashing light, in relation to the start of the opening operation from a voluntary command. 00 - Minimum 05 - Maximum	0005 00
WC	WC - Setting of pre-flashing time on closing. [s] Adjustment of the lead time for the switch-on of the flashing light, in relation to the start of the closing operation from a voluntary command. 00 - Minimum 05 - Maximum	0005 00
TS	TS - Setting of renewal of automatic closing time after safety device release. [%] 00 - Minimum 99 - Maximum	0099 99
VR	VR - Setting of learning speed. [cm/s]	0510 05 08 (Neos Super Fast)



N.B.: make adjustments gradually and only after performing at least three complete operations to allow the control panel to be set correctly and detect any friction during operations.

8. Display visualisation mode



WARNING: depending on the type of automation and control panel, some menus may not be available.









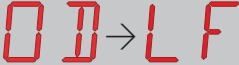

8.1 Display of automation status



The automation status display mode is only visible with Display visualisation mode set to 02.

AP → DS → 02

Display	Description
	Automation closed.
	Automation closed. Release door open.
	Automation open.
	Automation open. Release door open.
	Automation stopped in intermediate position.
	Automation stopped in intermediate position. Release door open.
	Automation closing.
	Automation that slows down during closing.
	Automation opening.
	Automation that slows down during opening.

Display	Description
	
	Automation closed.
	Automation closed. Release door open.
	Automation open.
	Automation open. Release door open.
	Automation stopped in intermediate position.
	Automation stopped in intermediate position. Release door open.
	Automation closing.
	Automation that slows down during closing.
	Automation opening.
	Automation that slows down during opening.













8.2 Display of safety devices and commands



















The safety device and command display mode is only visible with Display visualisation mode set to 01 or 03.

AP → DS → 01

AP → DS → 03

Display	Description
	1-3 - Opening command.
	1-4 - Closing command.
	1-5 - Step-by-step command.
	1-6 - Safety device with opening and closing stop.
	1-8 - Safety with closing reversal.
	P3 - Partial opening command.
	3P - Opening command with operator present.
	4P - Closing command with operator present.
	RX - Radio reception (of any memorised key of a transmitter present in the memory).
	NX - Radio reception (of any non-memorised key).
	EX - Rolling-code radio reception out of sequence
	EP - Radio reception not complying with the parameter configuration RO → EP

	CX - Receipt of command from AUX card.
	F1 - Closing limit switch
	F2 - Opening limit switch
	O1 - Detection of an obstacle during closing
	O2 - Detection of an obstacle during opening
	O0 - Reaching of obstacle detection limit during opening
	OC - Reaching of obstacle detection limit during closing
	S1 - Detection of stop during closing
	S2 - Detection of stop during opening
	SW - Release door open. When the release door is closed, the control panel performs a RESET (alarm )
	RV - Enabling/disabling of built-in radio receiver via JR3.
	MQ - Learning operation of mechanical end stops in progress.
	HT - Heating of the motors (NIO function) in progress.
	hr - Indicates OPERATOR PRESENT mode (hold to run).
	J1 - Variation of the JR1 jumper status.





8.3 Display of alarms and faults



Alarms and faults can be displayed with any display selection. The signalling of alarm messages takes priority over all other displays.

Type of alarm	Display	Description	Operation
Mechanical alarm		M0 - Selected motor not suitable.	Set correct motor wiring.
		M3 - Automation blocked (open/closed)	Check the mechanical parts
		M4 - Motor short circuit	Check the motor is correctly connected. Check the motor is working properly.
		M8 - Gate too long error (>25 m)	Check the rack / chain belt
		M9 - Gate too short error (< 200 mm)	Manually check that the door wing moves freely.
		MB - Absence of motor during an operation.	Check connection of motor. Check motor brush contacts. If the problem persists, contact Technical Support.
		MD - Irregular functioning of motor opening limit switch.	Check connection of the motor opening limit switch.
		ME - Irregular functioning of motor closing limit switch.	Check connection of the motor closing limit switch.
		MI - Detection of fifth consecutive obstacle.	Check for the presence of permanent obstacles along the stroke of the automation.
		ML - Inverted limit switches	Check limit switch connection.
Power supply operations alarm		R0 - Insertion of a storage module containing over 100 stored remote controls. Warning: R0 → MU → 20 is set automatically. The alarm is displayed 3 times only.	To save the system configurations on the storage module, delete any stored remote controls and bring the total to less than 100. Set R0 → MU → 10 .

Type of alarm	Display	Description	Operation
Power supply operations alarm	R3	R3 - Storage module not detected (with JR3=ON).	Insert a working storage module or set JR3=OFF.
	R5	R5 - Storage module not working (regardless of JR3)	Replace the storage module.
Accessories alarm	A0	A0 - Failure of test of safety sensor on contact 6.	Check that device SOFA1-A2/GOPAV is working correctly. If the supplementary card is not inserted, check that DB is not set to S41/P41
	A3	A3 - Failure of test of safety sensor on contact 8.	Check that device SOFA1-A2/GOPAV is working correctly. If the supplementary card is not inserted, check that DB is not set to S41/P41
	A9	A9 - Flashing light output short circuit alarm	Check that the flashing light is working properly.
Power supply alarm	P1	P1 - Microswitch voltage too low	Check the control panel is powered correctly.
Control panel internal alarm	I7	I7 - Internal parameter outside limits error	Reset. If the problem persists, contact Technical Support.
	I8	I8 - Program sequence error	Reset. If the problem persists, contact Technical Support.
	IA	IA - Internal parameter error (EEPROM)	Reset. If the problem persists, contact Technical Support.
	IB	IB - Internal parameter error (RAM)	Reset. If the problem persists, contact Technical Support.
	IC	IC - Operation time out error (>5 min or >7 min in acquisition mode)	Manually check that the door wing moves freely. If the problem persists, contact Technical Support.
	IH	IH - Overcurrent with motor switched off alarm	Reset. If the problem persists, contact Technical Support.

Type of alarm	Display	Description	Operation
Control panel internal alarm		IM - Shortcircuited motor MOSFET alarm	Reset. If the problem persists, contact Technical Support.
		IO - Interrupted power circuit (motor MOSFET open)	Reset. If the problem persists, contact Technical Support.
		IR- Motor relay malfunctioning	Reset. If the problem persists, contact Technical Support.
		Firmware reset (SIGNAL ONLY)	
Service		V0 - Request for maintenance intervention	Proceed with the scheduled maintenance intervention.

9. Start-up



WARNING The operations related to point 5 are performed without safety devices. The display parameters can only be adjusted when the automation is idle. The automation automatically slows when approaching the end stops or stop limit switches.
At every start-up the control panel receives a RESET and the first operation is performed at reduced speed (automation position acquisition).

- 1- Make a jumper for NC safety contacts.
 - 2- Adjust the opening and closing stop limit switches, if any.
N.B.: The limit switches must remain pressed until the operation is completed and placed as shown in the Ditec NEOS installation manual.
 - 3- Set the desired opening direction from the **AT** menu.
 - 4- Manually move the sliding gate and make sure the entire stroke slides evenly and without friction.
 - 5- Switch on and check the automation is operating correctly with the subsequent opening and closing commands (see paragraph 7.2).
Check that the limit switches are activated if used.
 - 6- Connect the safety devices **D6** and **D8** → **S4** (removing the relative jumpers) and check they are working correctly.
 - 7- To modify the operation and deceleration speed settings, automatic closing times and thrust on obstacles, consult the menus.
 - 8- Connect any other accessories and check they are functioning.
- WARNING:** Ensure that the forces exerted by the door wings are compliant with EN12453-EN12445 regulations.
- 9- If required, store the remote controls using command **RO** → **SR**.
 - 10- Once the start-up and check procedures are completed, close the container.



N.B.: in the event of servicing or if the control panel is to be replaced, repeat the start-up procedure.

10. Troubleshooting

Problem	Possible cause	Alarm signalling	Operation
The automation does not open or close.	No power.		Check power supply cable.
	Short circuited accessories.		Disconnect all accessories from terminals 0-1 (a voltage of 24V= must be present) and reconnect them one at a time. Contact Technical Service
	Blown line fuse.		Replace fuse.
	Safety contacts are open.	I-6 I-8	Check that the safety contacts are closed correctly (NC).
	Safety contacts not correctly connected or self-controlled safety edge not functioning correctly.	A0 A3 I-6 I-8	Check connections to terminals 6-8 on control panel and connections to the self-controlled safety edge.
	SAFETY SWITCH release microswitch open.	SW	Check that the hatch is closed correctly and the microswitch makes contact.
	Photocells activated.	I-6 I-8	Check that the photocells are clean and operating correctly.
	The automatic closing does not work.		Issue any command. If the problem persists, contact Technical Service
	Mechanical fault	M3 M8	Check the rack or transmission chain, and/or the mechanical parts.
	Faulty motor	M4 M8	Check motor connection, if the problem persists, contact Technical Service.
Faulty control panel	I 7 I 8 I A I B I H I M I O I R	Contact Technical Service.	
The external safety devices are not activated.	Incorrect connections between the photocells and the control panel.		Check that I-6 / I-8 is displayed Connect NC safety contacts together in series and remove any jumpers on the control panel terminal board. Check the AP → J6 and AP → J8 setting

The automation opens/closes briefly and then stops.	There is a presence of friction.	M9 IC MI	Manually check that the automation moves freely and check the R1/R2 adjustment Contact Technical Service
The remote control has limited range and does not work with the automation moving.	The radio transmission is impeded by metal structures and reinforced concrete walls.		Install the antenna outside.
			Replace the transmitter batteries.
The remote control does not work	No storage module or incorrect storage module.	R0 R3 R5	Switch the automation off and plug in the correct storage module.
			Check the correct memorisation of the transmitters on the built-in radio. If there is a fault with the radio receiver that is built into the control panel, the remote control codes can be read by removing the storage module.
The flashing light is not working	Bulb burnt or flashing light wires detached or short-circuited.	A9	Check the bulb and/or wires. Contact Technical Service

11. Examples of sliding gate applications

When the CS12E control panel is used for sliding automation applications, the following connections can be made:

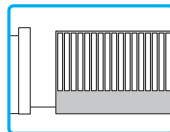

- set the correct opening direction:

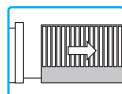

⏏ ⏏ AT ⏏ ENTER ⏏ ⏏ RT ⏏ ENTER x2 s ⏏ OK

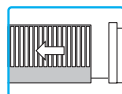

⏏ ⏏ AT ⏏ ENTER ⏏ ⏏ LF ⏏ ENTER x2 s ⏏ OK

Example 1 - Door wing stops against mechanical end stops (standard setting)

Set

⏏ ⏏ AP ⏏ ENTER ⏏ ⏏ FA ⏏ ENTER NO ⏏ ENTER ⏏ OK

⏏ ⏏ AP ⏏ ENTER ⏏ ⏏ FC ⏏ ENTER NO ⏏ ENTER ⏏ OK

Example 2 - Door wing stops against limit switches (setting with standard limit switches installed)

Connect the limit switches to the terminal

LSW	

Set

⏏ ⏏ AP ⏏ ENTER ⏏ ⏏ FA ⏏ ENTER Sx ⏏ ENTER ⏏ OK

⏏ ⏏ AP ⏏ ENTER ⏏ ⏏ FC ⏏ ENTER Sx ⏏ ENTER ⏏ OK

With these settings, if an obstacle is detected while opening, the door wing stops and performs a disengagement operation whereas during a closing operation, the door wing reopens.

Example 3 - Door wing stops against mechanical end stops and reverses motion if an obstacle is detected

Connect the limit switches to the terminal

LSW	

Set

⏏ ⏏ AP ⏏ ENTER ⏏ ⏏ FA ⏏ ENTER Px ⏏ ENTER ⏏ OK

⏏ ⏏ AP ⏏ ENTER ⏏ ⏏ FC ⏏ ENTER Px ⏏ ENTER ⏏ OK

In this configuration, the door wing stops against its respective mechanical closing and opening end stop. In the event of obstacle detection before the activation of the proximity limit switch while opening, the door wing stops, performing a disengagement operation; after the proximity limit switch is activated, the door wing stops against the obstacle.

In the event of obstacle detection during closing and before the activation of the proximity limit switch, the door wing reopens; after the proximity limit switch is activated, the door wing stops against the obstacle.

All the rights concerning this material are the exclusive property of Entrematic Group AB. Although the contents of this publication have been drawn up with the greatest care, Entrematic Group AB cannot be held responsible in any way for any damage caused by mistakes or omissions in this publication. We reserve the right to make changes without prior notice. Copying, scanning and changing in any way are expressly forbidden unless authorised in writing by Entrematic Group AB.

Entrematic Group AB
Lodjursgatan 10
SE-261 44, Landskrona
Sweden
www.entrematic.com

ENTRE//MATIC

